



***INSTRUCTION & OPERATIONS
MANUAL***

***ATOMIC HYDROGEN MASER
FREQUENCY STANDARD***

MODEL MHM-2010

Symmetricom Part Number: 75666-201

Rev. G

Dated: November 7, 2006



Symmetricom Standard Warranty for Sigma Tau Maser

Symmetricom warrants that for a period of seven (7) years from date of shipment the Product a) will be free from defects in design, material, and workmanship; b) will conform to and perform in accordance with Symmetricom's specifications; and c) will have good and valid title; and will be free and clear of any and all liens and encumbrances ("Warranty"). This Warranty will survive inspection, acceptance, and payment by Customer.

Symmetricom does not warrant that the operation of the Product will be uninterrupted or error free. This Warranty does not cover failures caused by acts of God, electrical or environmental conditions; loss or damage in transit; or improper site preparation.

This Warranty shall be null and void in the event (i) Customer or any third party attempts repair of the Product without Symmetricom's advance written authorization; or (ii) defects are the result of improper or inadequate maintenance by Customer or third party; (iii) of damage to said Product by Customer or third party-supplied software, interfacing or supplies; or (iv) of improper use (including failure to follow specified start-up procedures, termination of non-certified third party equipment on Symmetricom's proprietary interfaces and operation outside of the product's specifications) by Customer or third party; or (v) the Product is shipped to any country other than that originally specified in the Customer's purchase order.

Product not meeting the foregoing Warranty will be repaired or replaced, at Symmetricom's option, in accordance with the following repair procedure:

Symmetricom will first endeavor to support repair by module exchange, with the Customer doing the actual work of exchange of modules. Symmetricom will provide Customer with the replacement modules, supporting documentation and real-time telephone support (8 A.M.-5 P.M.- CST). Symmetricom will bear the cost of shipping the replacement modules to the Customer. Symmetricom will not issue an invoice for the replacement unit. Customer must return the defective module back to Symmetricom's Sigma Tau facility within thirty (30) days. If the Customer fails to return the defective module within thirty (30) days, Symmetricom will issue an invoice for the replacement module. Symmetricom customer assistance center must be notified in advance of any return by Customer. The defective module is to be returned, packaged in accordance with normal commercial practices to prevent damage, marked with the return material authorization ("RMA") number and freight prepaid by Customer. Units returned without an RMA number will not be accepted for delivery at Symmetricom and will be returned to the Customer at Customer's expense.

Where the Customer is unable to perform the module exchange repair with Symmetricom telephone technical assistance, Symmetricom will send a technician or an engineer to the Customer site. Symmetricom would expect the Customer to support data acquisition from the defective module so that Symmetricom could arrive at the Customer site with the proper modules to effect the repair. Symmetricom will arrange to provide on-site visit as soon as reasonably possible, consistent with personnel availability and flight availability. The cost of the travel will be split equally between Symmetricom and the Customer; the labor and material costs will be borne by Symmetricom.

If the Product cannot be repaired by either of the foregoing options, Symmetricom will ask that the Customer ship the maser back to the Sigma Tau facility. The Customer shall package the maser in a Symmetricom shipping crate, marked with the RMA number and freight prepaid by Customer. Upon Customer's request, Symmetricom, will provide the Customer, at Customer expense, with a shipping crate to return the defective Product. Upon return to factory, Symmetricom, at its cost, will repair the Product and ship it back to the Customer. If Customer requires on-site installation support personnel, Symmetricom will provide such on-site support in accordance with its then current price for on site installation for new masers.

THE FOREGOING WARRANTY IS IN LIEU OF ALL OTHER WARRANTIES, EXPRESSED OR IMPLIED, INCLUDING, BUT NOT LIMITED TO, ANY IMPLIED WARRANTIES OF TITLE, MERCHANTABILITY, OR FITNESS FOR A PARTICULAR PURPOSE HOWSOEVER ARISING.

**The Model MHM-2010 Atomic Hydrogen Maser
Frequency Standard**

Instruction and Operations Manual

Symmetricom
Sigma Tau Standards Group
1711 Holt Road, Tuscaloosa, Alabama 35404
TEL: (205) 553-0038, FAX: (205) 553-2768

Contents

Chapter I – Introduction	1
The Maser Operation	1
Auto-Tuning.....	1
Chapter II – Specifications	2
Standard Outputs and Performance	2
Environmental Sensitivity.....	2
Power Supply and Battery Back-Up.....	2
General Specifications	2
Nominal Maser Parameters and Calibration Factors	3
Chapter III – Operating Instructions	4
General Procedures	4
Manual Instrumentation and Data Monitoring	4
Channel No. 0 IF Amplitude.....	4
Channel No. 1 Cavity Register.	4
Channel No. 2 VCO Control Voltage.....	4
Channel No. 3 Hydrogen Ion Pump.....	4
Channel No. 4 Upper Ion Pump.....	4
Channel No. 5 1,400 MHz LO Amplitude.....	5
Channel No. 6 Cavity Heater Voltage.	5
Channel No. 7 Outer Oven Heater.....	5
Channel No. 8 Lower Support Heater.	5
Channel No. 9 Top Temperature Control Heater.	5
Channel No. 10 Source Discharge Circuit Current.....	5
Channel No. 11 Battery Charge Current.....	5
Channel No. 12 Thermal Shield Heater.....	5
Channel No. 13 VCO Heater.	5
Channel No. 14 Main Magnetic Field.	5
Channel No. 15 Hydrogen Pressure.....	5
Channel No. 16 Pirani Gauge Heater.....	5
Channel No. 17 Palladium Heater.	6
Channel No. 18 Source Discharge Transistor Collector.....	6

Channel No. 19 Battery Voltage.....	6
Channel No. 20 Main Bus Voltage.....	6
Channel No. 21 Cavity Averager.....	6
Channel No. 22 Main AC-DC Output #1.	6
Channel No. 23 Main AC-DC Output #2.	6
Channel No. 24 External DC Input.....	6
Channel No. 25 Bottle Heater.....	6
Channel No. 26 IF Alarm.....	6
Channel No. 27 VCO Alarm.....	6
Channel No. 28 Register Limit Alarm.....	7
Channel No. 29 DC Ext. Available.....	7
Channel No. 30 AC 1 & 2 Available	7
Channel No. 31 On Battery (Alarm)(Battery In Use Alarm).	7
Data Display List	8
Receiver, VCO & Synthesizer Systems.....	9
Receiver, VCO & Synthesizer Systems.....	9
Modifying the Synthesizer Setting	9
Adjusting Crystal VCO Frequency.....	9
VCO Turn On	9
Source Pressure Control.....	10
Adjusting Maser Oscillation Level.....	10
Source Discharge	11
Restart The Source Discharge After Being Turned Off	11
Magnetic Field Control.....	11
Degaussing.....	11
Cavity Servo System.....	11
Power Supply System	12
Chapter IV – Transportation and Installation	13
Transportation Requirements.....	13
Fully Operational	13
Partially Shut Down.....	13
Fully Shut Down.....	14
Installation	14

System Levels & Equilibrium.....	14
Appendix A – Remote Operation	15
Remote Monitoring and Control Overview	15
Serial Communication	15
Appendix B – Remote Command Set.....	17
Command Overview	17
cmc	18
cmf	19
cmh.....	20
s	21
t	22
Appendix C – Figures and Diagrams	23
Figure 1 Hydrogen Maser Elevation.....	24
Figure 2 Maser Block Diagram	25
Figure 3 Hydrogen Maser, System Layout and Identification.....	25
Figure 4 Hydrogen Maser, Physics Layout and Identification	27
Figure 5 Stability Plot, Typical.....	28
Appendix D – Start-up Procedure.....	29
Appendix E – MaserMonitor Information	39
Requirements	39
Supported Instruments	39
Installation	39
Usage.....	39
Appendix F – References	43
Index	44

Chapter I – Introduction

The Symmetricom Model MHM-2010 atomic hydrogen maser frequency standard is an active oscillator with a natural output frequency of 1,420,405,751.xxx Hz derived from quantum transitions between two of the four magnetic "hyperfine" levels of the ground electronic state of atomic hydrogen. This is the well known 21 cm atomic hydrogen line.

The Maser Operation

A small storage bottle supplies molecular hydrogen under electronic servo control to the source discharge bulb where the molecules are dissociated into atoms. Atoms emerge from the source through a small elongated hole known as the source collimator and then pass through a magnetic state selector that directs a beam of atoms in the correct quantum state to a Teflon coated quartz storage bulb. A microwave cavity, resonant at the hydrogen transition frequency, provides the proper environment to stimulate maser action that causes the atoms to produce microwave emissions. A small loop couples the microwave signal from the microwave cavity to the receiver/synthesizer system through a coaxial cable.

The signal from the cavity passes to a low noise, heterodyne receiver system containing a high resolution frequency synthesizer, and a phase-locked loop locks a voltage controlled crystal oscillator (VCO) to the maser output. Integral multipliers, dividers and buffer amplifiers under temperature control provide several isolated outputs at standard frequencies. To insure proper environment for maser action and minimize systematic perturbations of the maser output frequency, sputter-ion pumps maintain a high vacuum and getter the hydrogen. Magnetic shielding surrounds the cavity and a multi-level thermal control system provides isolation from external temperature variations. An axial magnetic field coil wound on the inside of the first shield provides control of the internal magnetic field also known as the C Field.

Auto-Tuning

The maser incorporates an automatic frequency control system to maintain the cavity at a constant frequency relative to the hydrogen emission line. This cavity servo, using the cavity frequency-switching method, requires no other stable frequency references in its operation. Unlike conventional automatic spin-exchange tuning, the maser does not require beam intensity switching, so the cavity servo system does not significantly degrade the maser short term stability or phase noise. Organizations requiring the best long term stability and reproducibility will find the auto-tuning system crucial to realizing their goals.

Chapter II – Specifications

Standard Outputs and Performance

- A. **Standard Frequency Outputs:** There are three 5 MHz, one 10 MHz and one 100 MHz signals with 1 volt RMS output resistively matched to 50Ω loads. An additional output at 100 MHz is available as an option. A one pulse per second timing output is also available as an option with auto sync to an input applied to the sync input. The output signals all have type N connectors and are located on the back of the maser.
- B. **Stability, time domain:** Figure 5 illustrates typical frequency stability in the time domain.
- C. **Power supply sensitivity:** For nominal line voltage changes or switching to batteries, the frequency will change by no more than $\pm 1 \times 10^{-14}$.
- D. **Frequency Adjustments:** The standard output frequencies are adjustable without phase discontinuity using digital panel switches with a resolution of 7.040×10^{-17} for the least significant digit. The maximum continuous adjustment range is limited only by the loop hold in range of the VCO to within $\pm 1 \times 10^{-8}$. The VCO frequency coarse adjustment may also be used to obtain offsets as large as $\pm 1 \times 10^{-6}$. Remote frequency control is also provided as indicated below.

Environmental Sensitivity

- A. **Magnetic field sensitivity:** For a ± 1 Gauss external field change, the maser frequency will change by less than $\pm 3 \times 10^{-14}$.
- B. **Temperature sensitivity:** Less than 1×10^{-14} /°C over a range of 20°C to 24°C.
- C. **Barometric pressure sensitivity:** Less than 1×10^{-14} /in. Hg.

Power Supply and Battery Back-Up

- A. **Power supply requirements:** Two universal input AC power supplies are installed. The voltage range is either 85 to 132 or 170 to 265 VAC (47-440Hz). The power required is typically 100 watts on AC, 150 watts maximum, with automatic crossover to batteries. On batteries, the typical current at 24 V is 3.1 A. If external DC power is used, the requirement is 22 to 28 V, 3.1 A (typical).
- B. **Standby battery operation:** Two 40 A-H, 12 V, sealed lead-acid, "maintenance free" batteries (Power Sonic PS12400 or equivalent) are mounted in a module on the rear of the maser. When fully charged these batteries will power the maser for over 8 hours. Automatic recharging occurs at approximately 1.5 A.

General Specifications

- A. **Size and weight:** The maser is 46 cm (18 in) wide by 76 cm (30 in) deep by 107 cm (42 in) high. The overall weight is approximately 215 kg (475 lb.) excluding batteries. The two batteries add 30 kg (66 lb.) to the maser weight.
- B. **Operating life:** The hydrogen supply is adequate for over 20 years of operation. The ion pumps have an expected lifetime of more than 20 years and may be changed on site.

- C. **Automatic cavity tuner:** A cavity frequency switching auto-tuner is continuously in operation and requires no operator control once set.
- D. **Instrumentation, local:** 32 channels of analog data, status and alarm signals are multiplexed and selected by the scroll switch, and displayed on the front panel.
- E. **Instrumentation, remote monitoring and control:** A monitor and control interface circuit is installed for remote monitoring of all 32 data channels and control of the maser synthesizer. Connection is made through a full duplex 25 pin serial port.

Nominal Maser Parameters and Calibration Factors

- A. Cavity Loaded Q: 40,000
- B. Operating Line Q: 2×10^9
- C. Cavity/Line frequency ratio: 2×10^{-5}
- D. Approx. pressure shift ratio at first V_p setting: 2:1
- E. Approx. synthesizer calibration factor: $7.040,24 \times 10^{-17}/\text{Digit}$
- F. Initial Modulation Period Generator Setting: $M = 5.2000$
- G. Cavity register calibration factor: 4×10^{-11} full scale (10 volts),
 $4 \times 10^{-15}/\text{mV}$ ref. to maser output frequency.
- H. Cavity temperature: $51.0 \text{ }^\circ\text{C}$
- I. Outer oven and lower support temperatures: $50.5 \text{ }^\circ\text{C}$
- J. Maser basic frequency (f_0): $1,420,405,751.770,00 \text{ Hz}$
- K. Basic frequency adjustments:
 Second order Doppler @ 51°C : $-0.062,58 \text{ Hz}$.
 Wall shift (approx.) @ 51°C : $-0.038,64 \text{ Hz}$
 Assumed magnetic field 0.500 mG: $+0.000,68 \text{ Hz}$
 $\{(f_2 - f_1)\}_H = 2750 \text{ H}^2 \text{ Hz}$.
 Total frequency adjustment @ 0.500 mG: $-0.100,54 \text{ Hz}$
- L. Oscillation frequency @ 0.500 mG: $1,420,405,751.669,46 \text{ Hz}$
- M. Corresponding synthesizer setting: $N = 5,751.669,460,0$
- N. The exact relationship between the maser oscillation frequency and the 5 MHz standard output frequency is given by: $f_{\text{out}} = f_{\text{M}}/(284.08 + 2 \times 10^{-7} N_s)$
 where $N_s = n,\text{nnn}.\text{nnn},\text{nnn},n$

Chapter III – Operating Instructions

General Procedures

After installation and establishment of normal operation, there are no further routine operating procedures for the maser other than observation of instrumental data and occasional checking (or 24 month replacement) of standby batteries. Operating procedures associated with the external data interface are described in the **Appendix A, Remote Operation**. In order to anticipate problems and assure reliable operation, we recommend that an hourly log of the instrument readings be kept. More frequent observation would naturally be appropriate for operation-critical applications. If unusual requirements exist, or the instrumental data indicates testing the maser systems or adjusting the panel controls is warranted, the procedures described below are recommended.

Manual Instrumentation and Data Monitoring

Multiplexer Channel Controls. There are 32 channels of instrumental, status, and alarm data which may be selected for readout on a digital LCD display. The “Scroll” switch located to the right of the display allows viewing of several screens that show channel data, several alarm conditions, and the external and internal synthesizer numbers.

Channel No. 0 IF Amplitude.

This gives a reading of the receiver 405,751.xxx Hz second-IF amplitude. For best operation of the cavity servo system the panel meter should read between 1.5 and 7.5 V. A typical reading with the pressure set at "LOW" (the normal setting) is between 3 and 5 volts. At "HIGH" pressure, the typical reading is between 5 and 7.5 volts.

Channel No. 1 Cavity Register.

The Cavity Register voltage is the output voltage of the automatic cavity frequency control servo system which goes to a varactor diode to control the cavity frequency. The voltage range is 0 to 10 volts and the frequency calibration factor is approximately 5×10^{-12} per volt referenced to the maser output frequency.

Channel No. 2 VCO Control Voltage.

The VCO control voltage is a buffered direct readout of the electronic frequency control voltage applied to the voltage controlled crystal oscillator used in the receiver phase locked loop. The front panel lock indicator will register alarm (red or amber) if the voltage is outside the range of approximately ± 1.0 volts.

Channel No. 3 Hydrogen Ion Pump.

This gives the current in the hydrogen ion pump, which is the vacuum pump which getters the hydrogen flux. The calibration factor is 1 volt per milliamp.

Channel No. 4 Upper Ion Pump.

This gives the current in the upper ion pump, which getters the vacuum region outside the storage bulb and source region. The calibration factor is 1 volt per milliamp.

Channel No. 5 1,400 MHz LO Amplitude.

This is the voltage from the diode detector on the test port on the 1,400 MHz output of the local oscillator circuit.

Channel No. 6 Cavity Heater Voltage.

This is the voltage across the heater for the cavity temperature controller.

Channel No. 7 Outer Oven Heater.

This is the voltage across the heater for the outer oven temperature controller (the vacuum enclosure cylinder).

Channel No. 8 Lower Support Heater.

This is the voltage across the heater on the lower support temperature control station (the vacuum enclosure base plate).

Channel No. 9 Top Temperature Control Heater.

This is the voltage across the heater on the top plate temperature control station.

Channel No. 10 Source Discharge Circuit Current.

This voltage represents the emitter current in the source discharge oscillator power transistor. The calibration factor is 1 V/A.

Channel No. 11 Battery Charge Current.

The monitor displays the battery charge current. When the batteries are fully charged, the current is typically between 0.05 and 0.02 amperes. When charging a low battery, the current maximum is 1.5 amperes. The calibration factor is 1 V/A.

Channel No. 12 Thermal Shield Heater.

This is the voltage across the heater on the thermal shield temperature control station (intermediary between the cavity and the outer oven).

Channel No. 13 VCO Heater.

This is the voltage on the crystal VCO temperature control heater.

Channel No. 14 Main Magnetic Field.

This voltage represents the main magnetic field intensity (Z axis field in the maser cavity interaction region). The voltage is fixed in normal operation at 0.5 V and represents a 500 microgauss main field intensity. A banana plug connector next to the pressure controls allows application of a different field for test purposes, or to short the field to zero when degaussing. **Note: This voltage should not exceed +/- 5 volts.**

Channel No. 15 Hydrogen Pressure.

This is a bias voltage applied to the pressure control bridge circuit to set the hydrogen source pressure.

Channel No. 16 Pirani Gauge Heater.

This is the voltage across the heater of the pressure gauge sensor element (Pirani gauge).

Channel No. 17 Palladium Heater.

This is the voltage across the heater which supplies heat to the palladium purifier element in the hydrogen supply module that regulates hydrogen flow to the source discharge bulb.

Channel No. 18 Source Discharge Voltage.

This is the voltage applied to the collector of the source oscillator transistor. The circuit is current limiting and a value below approximately 21.5 volts indicates that the source circuit may not be tuned properly. The limiting current is approximately 0.75 amperes.

Channel No. 19 Battery Voltage.

When charged, VBat is 27.0 to 27.5 volts; when the maser is on batteries, the voltage is near 24 volts, and when nearly discharged, the voltage falls below 23.5 volts. Fully discharging the batteries may severely limit battery capacity or require battery replacement.

Channel No. 20 Main Bus Voltage.

This channel indicates the regulated main bus voltage that feeds all internal electronic systems.

Channel No. 21 Cavity Averager.

This is the output of a D/A ladder network connected to the first two Up/Down counters in the cavity register circuit. It indicates the direction and rate at which clock pulses are input to the counters and is primarily used for diagnostic or setup purposes. The range is 0 to 4 volts and varies continuously unless the register is on hold.

Channel No. 22 Main AC-DC Output #1.

AC1 is one of two Main AC-DC supplies installed on the maser, either of which (or DCx, below) will supply all the power to the maser .

Channel No. 23 Main AC-DC Output #2.

AC2 see AC1, above.

Channel No. 24 External DC Input.

External DC input: Either AC1, AC2 or DCx will supply all power to the maser. If all three are off, the maser will go to batteries.

Channel No. 25 Bottle Heater

This channel is used for monitoring the bottle heater voltage.

Channel No. 26 IF Alarm.

If the IF signal (Channel 0) is less than 2.5 volts an alarm will be shown on Channel 26. Channel 26 output is a logic level where 1.0 volt or greater means OK and less than 0.2 volt means alarm.

Channel No. 27 VCO Alarm.

If the receiver VCO (Channel 2) goes out of lock, an alarm condition will be displayed on Channel 27. The logic levels are the same as in Channel 26.

Channel No. 28 Register Limit Alarm.

If the cavity register (Channel 1), the output of which controls the cavity frequency via the cavity servo, reaches either a + or - limit, a limit alarm will be displayed on Channel 28. The logic levels are the same as in Channel 26.

Channel No. 29 DC Ext. Available

If DCx is not present or fails, Channel 29 will display an alarm. The logic is the same as in Channel 26.

Channel No. 30 AC 1 & 2 Available

If either AC1 or AC2 is disconnected or fails, Channel 30 will display an alarm. The logic is the same as in Channel 26.

Channel No. 31 On Battery (Alarm)(Battery In Use Alarm).

If neither AC1, AC2 nor DCx are present, Channel 31 will display an alarm condition. A voltage <1 volt indicates that batteries are being used. An audible alarm will sound and a front panel led will be illuminated red when operating on batteries.

(See Data Display List on next page.)

**Data Display List
at 22°C ambient**

Channel Number Decimal	Channel Name	Typical Value (Volts)	Nominal Range (Volts)	
0	IF Amplitude	4.xxx	1.5 to 7.5	
1	Cavity Register	5.xxx	0 to 10	
2	VCO Control Voltage	0.00	+1.0 to -1.0	
3	VI Pump (H2)	0.04	-0.01 to 0.15	
4	VI Pump (Upper)	0.04	-0.01 to 0.15	
5	Local Oscillator	0.25	0.15 to 0.6	
6	Cavity Heater	2.7	2 to 6	
7	Outer Oven Heater	8.0	7.0 to 15	
8	Lower Support Heater	8.0	7.0 to 15	
9	Top Plate Heater	5.0	2 to 8	
10	Discharge Current	0.40	0.01 to 1.5	
11	Battery Charge	0.05	-0.02 to +1.5	
12	Thermal Shield	5.0	5.0 to 10	
13	VCO Heater	1.30	1.0 to 4.5	
14	Main Magnetic Field	0.50	-0.6 to +0.6	
15	Hydrogen Pressure	5.60	+5.5 to +7.5	
16	Pirani Gauge Heater	10.0	8.0 to 14.0	
17	Pd. (H ₂ Valve) Heater	10.0	4 to 16	
18	Discharge Voltage	23.7	21 to 26	
19	Battery Voltage	27.2	27.0 to 27.5	
20	Main bus	23.5	23-26	
21	Averager	Random	0 to 5	
22	AC-DC #1	27.6	26 to 29.5	
23	AC-DC #2	27.6	26 to 29.5	
24	DCx (When Present)	24.0	23 to 28	
25	Bottle Heater	14.5	10 to 16	
26	IF Amplitude Alarm	1.0	0.8 to 1.2 OK	0 to 0.2 AL
27	VCO Lock Alarm	1.0	0.8 to 1.2 OK	0 to 0.2 AL
28	Register Limit Alarm	1.0	0.8 to 1.2 OK	0 to 0.2 AL
29	DC Ext. Available	1.0	0.8 to 1.2 OK	0 to 0.2 AL
30	AC 1 & 2 Available	1.0	0.8 to 1.2 OK	0 to 0.2 AL
31	Battery in Use (Alarm)	1.0	0.8 to 1.2 OK	0 to 0.2 AL

Receiver, VCO & Synthesizer Systems

Normally, only the following situations in the receiver system require attention: resetting the synthesizer to change the maser standard output frequency or phase; the crystal oscillator drifts such that the VCO control voltage is outside the nominal range of -1 to +1 V; upon system setup or inspection it is found desirable to readjust the crystal coarse frequency control; the system has been down for repair and new settings are indicated; or to check or reset the cavity modulation phase delay setting.

Modifying the Synthesizer Setting

Within the limits of the 8 least significant digits, the synthesizer may be set to achieve any output frequency or phase relationship desired. If resetting the synthesizer causes the VCO control voltage to be outside the maximum range of -1 to +1 V, it may be necessary to adjust the voltage controlled oscillator (VCO) coarse frequency control (see below). To set the phase of the maser output frequency in agreement with an external signal, the synthesizer may be offset in frequency for a period of time and reset in frequency when the phases match.

The nominal synthesizer calibration factor is 7.04024×10^{-17} per digit. An increase in number gives a decrease in the standard output frequency. Except for large changes, which exceed the lock range of the VCO, changes to the synthesizer are coherent with the maser signal (i.e. free of phase discontinuities). To set the synthesizer using the serial interface, see Appendix A.

The exact relationship between the maser frequency, f_m , and the standard output frequency, f_o is:

$$f_o = f_m / (284.08 + 2 \times 10^{-7} \times N_s),$$

where $N_s = n,nnn.nnn,nnn,n$ (nom. 5,751.674,740,0) is the synthesizer number and f_o is the 5 MHz output.

Adjusting Crystal VCO Frequency

If a relatively large offset in the output frequency has been instituted by resetting the synthesizer, or if the VCO drifts out of lock range, the control voltage may be reset by using the VCO coarse adjustment. The coarse frequency adjustment of the VCO is accessed via a hole in the VCO module. The closed loop control voltage is set near 0 volts to assure automatic loop lock if the loop has been previously opened for any reason.

VCO Turn On

When the crystal VCO has been turned off, as for shipping or other reasons, it will take approximately 20 minutes for the VCO oven temperature control to stabilize, at which time the frequency will normally be within the lock range of approximately $\pm 1 \times 10^{-8}$. When the loop is unlocked, the lock indicator on the front panel will be red or amber, and when lock occurs, a phase beat and lock-up excursion will occur and the light will turn green.

If confirmation of lock is desired, the 8th digit of the frequency synthesizer may be changed up or down one digit and a corresponding change of about 50 mV in the VCO voltage will indicate lock. If the loop is unlocked, or the VCO control voltage is out of the desired range, the VCO coarse frequency may be reset as above.

Source Pressure Control

The controls for hydrogen flow to the source discharge bulb consist of a HIGH/LOW switch and high and low pressure setting potentiometers located below the Modulation Period Generator (MPG) controls behind the left control panel cover. The maser is normally operated with the switch in the low position. As long as the maser IF amplitude (observed on Channel 0) is in the designated operating range, there is usually no reason to change the pressure settings: there is very little difference in frequency stability for the two settings.

Situations where it may be desirable to change the pressure adjustments or to use the HIGH/LOW switch are as follows: to check or reset the cavity MPG using the spin-exchange cavity tuning method; to restart the source discharge, or to readjust the maser oscillation level if long term drift of components in the source circuit or pressure control elements cause the pressure calibration to change.

Adjusting Maser Oscillation Level

The maser oscillation level may be adjusted with the high and low pressure setting potentiometers if drift of components in the pressure control system has occurred or there is a change in maser oscillation level for other reasons. Before adjusting the pressure settings be sure that system problems such as change in the IF gain or retuning of the source discharge or other problems are not the cause of the decreased amplitude.

Before proceeding it should be emphasized that the source pressure settings are only voltage bias settings within the pressure control servo, and not a calibrated indication of source pressure. The actual hydrogen flux level must be inferred from measurement of the maser power coupled from the cavity or from calculations involving the cavity parameters (cavity Q, coupling and MPG modulation width). Historical data showing previous IF levels or ion pump currents as well as relative maser stability or drift are also a function of oscillation level and may be used, with judgment, to infer the need for resetting the source pressure.

Typical values for VPC (low) and VPC (high) are 6.0 V and 6.5 V, respectively, but the actual values used should be checked against the original settings as delivered as they may vary by as much as +/-1 volt. Before making changes be sure the initial readings of source pressure, hydrogen ion pump current, and IF level are recorded. This is a very sensitive setting which should be made in small increments (between 6.0 and 6.5 volts the beam flux approximately doubles). The preset values of the High or Low pressure voltages are those judged best for the spin-exchange tuning adjustment of the MPG when setting up the system or when making checks for variation in the spin-exchange tuned cavity offset. When changing pressure for checking cavity tuning, it is only necessary to change the HIGH/LOW switch setting, the preset potentiometer adjustments are not normally changed.

Make changes in the pressure settings in increments of about 0.05 volts and, after a wait of about one hour for the pressure to stabilize, observe the resultant changes in IF level. After equilibrium has been reached, the IF voltage at low pressure should be in the range of approximately 3 to 5V, or near the recorded voltages noted at delivery.

Source Discharge

The source discharge may need attention if it has been turned off and is difficult to light or is pale or discolored or a malfunction is indicated by low or absent IF amplitude traceable to the source. (i.e. blown source discharge fuse or other reasons).

Restart The Source Discharge After Being Turned Off

If the source discharge and source pressure have been turned off, the pressure control circuit must first be turned on and allowed to reach equilibrium pressure before starting the source discharge. After the pressure has been on for about 1 hour, the discharge is started by turning on the source discharge switch on the power distribution board located behind the masers lower front cover, at which time the source should light. The maser should start oscillation shortly after the source is lighted. Raising the source pressure by setting the pressure High temporarily will expedite source lighting.

Magnetic Field Control

The internal magnetic field (the C-field) is fixed at approximately 500 microgauss. When troubleshooting the maser, the field may be externally controlled by applying an external bias to the field winding, or it may be shorted to ground. In normal operation no adjustment or setting of the magnetic field is required. All required output frequency changes are made with the receiver synthesizer, which has essentially infinite resolution and repeatability.

The C-field within the bulb interaction region is produced by an axial multi-turn coil wound on the inside surface of the inner magnetic shield. The approximate calibration of the field is 1 milligauss per milliamp. The field current is fixed at approximately 0.5 mA by a resistance divider and a precision voltage regulator located near the Monitor and Control multiplexer board. A connection to the field is provided on a banana plug terminal located near the pressure controls. When degaussing, the field is set to zero by shorting this terminal to ground. **Note: This voltage should not exceed ± 5 volts.**

Degaussing

Symmetricon hydrogen masers rarely need degaussing and inexperience with the procedure may cause problems requiring extensive repairs. The factory should be consulted before any attempt is made to degauss the maser.

Cavity Servo System

The cavity register integrates up or down signals and produces a voltage which corrects the cavity frequency by changing the bias on a varactor diode mounted inside the cavity. There is a "RUN/HOLD" switch, an "UP/DOWN" switch, a register "RESET" push button and a modulation On-Off switch (identified on the decal) near the MPG period control thumbwheel switches.

The input to the cavity register may be interrupted by using the RUN/HOLD switch. When the register is placed on hold, it may be manually incremented or decremented with the UP/Neutral/DOWN control switch. If the register reaches the up or down limit, the limit indicator above the front panel display will light, and the register will lock at the limit. A register reset

push button is located next to the "MOD. ON/OFF" switch. To reset the register, switch to HOLD, select either UP or DOWN and then press the RESET button. Upon reset, the register returns to a median voltage of about 5 volts. As soon as the register is RESET, the UP/Neutral/DOWN switch should be moved to Neutral (center position), or the register will count continuously in the direction on the switch (up or down) until it reaches the limit. When the UP/Neutral/DOWN switch has been returned to Neutral, the RUN/HOLD switch should be returned to RUN.

To manually control the cavity register voltage (and the cavity frequency), the Servo RUN/HOLD switch is placed on HOLD and the UP/Neutral/DOWN switch may then be used to increment or decrement the register. Use the UP/Neutral/DOWN switch to move the register to the desired value, then return the switch to Neutral and put the servo on RUN.

In normal use, the cavity servo is left fully active, and no manipulation of the controls is required. Situations which may require attention are: when the register limits have been reached; if the power system, including standby batteries, has been interrupted and the register setting lost; if it is desirable to turn off the maser oscillation for a long period and manual control of the register up/down controls is used to expedite the return to the tuned position; if it is desirable to test the servo system; or to accommodate "spin-exchange tuning."

Power Supply System

Other than periodic checking of standby batteries, only routine monitoring of the power supply system voltages is required (see the data display chart for proper voltage settings). The battery voltage and charging current should be checked regularly; no charging current and an exceptionally high VBat would imply an open battery fuse or a disconnected or faulty battery.

Long life, sealed, "Maintenance Free" batteries are used, but to assure reliability these should be checked on a regular schedule, particularly before anticipated extended interruption of AC or external DC power. A three ampere load test with the voltage measured as a function of time is recommended. The test should be stopped well before the batteries are fully discharged (a minimum end of test voltage of approximately 23.5 volts is suggested).

After recharging fully, the estimated maximum operating time should be conservatively set at about 80% of the test value. Replacement of the batteries is recommended every 2 years. When fully charged and in good condition, the residual "float" current should be about 0.02 amps or lower.

Chapter IV – Transportation and Installation

Transportation Requirements

The maser should be kept vertical while under transport. Although the maser is designed to withstand small deviations from vertical, shock and vibration under those conditions have a high probability of causing major internal damage. Shock and vibration during transport are the most frequent cause of damage or system malfunction; therefore, a "Soft Ride" vehicle and resilient restraints should be used.

NOTE: The maser contains small amounts of hydrogen and hydride. These are technically classified as hazardous goods by the U.S Department of Transportation and are subject to certain shipping regulations. Consult the factory for details on shipping regulations.

Fully Operational

The hydrogen maser is intended to be a continuously operating standard, and it may be transported while fully operational using the battery backup system under careful supervision. The batteries, if new and fully charged, will supply the required power for over 8 hours if the ambient temperature remains near room temperature. As the temperature drops, the required power will increase by about 2 W/°C. It is recommended that a 25% safety margin be allowed for battery operation, or about 6 hours maximum transport time without recharging. Transporting a maser while fully powered will minimize installation time and require only routine system observation to establish that any transient effects have stabilized.

Partially Shut Down

If it is required that the maser be partially shut down, individual systems may be turned off by throwing the appropriate switch. Shutting down the data display will not affect maser operation, but will only save about 3 watts, or about 0.1 A from the battery. Any other system shut down will require from a few hours up to several days to recover the original frequency and stability. For partially shut down shipment or storage it is recommended that the ion pumps and the cavity temperature control be left on. If very long term shipment or storage is planned, at least one ion pump should be left on. The shut-down sequence, in order, is (using toggle switches located behind the lower front panel):

1. Record the cavity register voltage and put the register on Hold;
2. Turn off the source discharge (DISCH);
3. Turn off pressure control (PC);
4. Turn off receiver and controls (switch on power conversion module);
5. Turn off outer oven, lower support and top plate temperature controls (TCPA);
6. Turn off cavity temperature control (TCA, - turn off only to minimize power consumption);
7. Turn off VIh & VIo (Do not turn VIh or VIo off while TCA is on - see note below);
8. Turn off Alarm (AL, alarm switch on back panel - disable the alarm only if the maser is being shipped on batteries).

Note: Do not turn off the Vacion pumps for any extended period without considering the possibility that it may be difficult to restart them with the internal pump power supplies. For

periods shorter than a one week the pumps will normally recover on the internal supply, but several hours or possibly days at saturation current in the Vacion supplies may be anticipated.

Fully Shut Down

The maser may be transported fully shut down, for example for air shipment, but it must be protected with a properly designed shipping crate (Symmetricom part number 75304-501) and the travel time without power should be minimized, but never exceeding 7 days. For air shipment fully shut down, it is recommended that the valves to the ion pumps be shut off to facilitate easy restarting. Warm-up time from a cold start is approximately 3 days.

The Symmetricom maser shipping crate has the following specifications:

Height: 135 cm (53 inches)

Width: 84 cm (33 inches)

Length: 122 cm (48 inches)

Supplied with integral shipping pallet

Empty weight: 123 kg (270 lbs)

The crate may be ordered from Symmetricom; please contact the factory for details.

Installation

For best performance the maser should be located in a relatively isolated area with minimal temperature transients. If the maser is fully operational upon receipt, it is only required that it be connected to the AC supply. The two AC supplies should be plugged into separately fused mains for protection against failure of one line. Separately fused AC lines provide a safeguard against other equipment causing a failure on one line. The batteries will charge in a time dependent upon the discharge level. Recharging from a completely discharged condition requires more than one day's time. A record should be made of instrumental data at installation and followed up closely for a few days to see if the maser systems are working normally. If the maser was received partially shut down, see Appendix D for the Start-up Procedure.

System Levels & Equilibrium

Monitor the register voltage and other parameters closely for a few days to confirm that cavity servo equilibrium has been reached and that all systems are operating within nominal parameters. An external PC monitoring the system parameters will provide the best means of determining the maser's operational status and servo performance (see **Appendix A** and **Appendix B** for remote operation).

Appendix A – Remote Operation

Remote Monitoring and Control Overview

The maser design provides for remote monitoring and control (M&C) of several of the maser's operating parameters through a serial port on the back panel. The serial port allows read access to the 32 analog data channels (also accessible from the front panel) and programming of the maser's synthesizer.

To safeguard against unintentional changes of the synthesizer frequency, the maser has a double lockout against external control. Although the M&C will accept programming instructions while on internal control, these instructions will not take effect until the maser is set to external control. To do this, set the front panel switch (located behind the maser right control panel door) to external control and send the configuration command (via serial port) to request external control. While on internal control, only the front panel thumbwheel switches control the maser synthesizer frequency.

Because the operation of the M&C waits for completion of valid commands, remote command functions have a window of about 50 seconds for the command to be completed or a time-out will occur. Times-outs can contribute to unexpected results, so be sure to complete all commands promptly before leaving the remote terminal idle.

See **Chapter III, Operating Instructions**, Data Display List for the names and functions of each of the 32 data channels.

Serial Communication

An RS-232C serial port located on the back panel of the maser (25 pin, DB25 female connector) handles remote access to the maser. **The maser is delivered with settings of 9600 baud, 8 data bits, no parity, 1 stop bit. These settings cannot be changed by the user.**

Only a basic subset of the RS-232C standard has been implemented as shown in **Table A4**, below.

Table A4. RS-232 Serial Port Pin-out.

Pin Number (DB25)	Pin Number (PCB)	Function/Signal (n.c. = no connection)
1	1	GND
2	2	TXD
3	3	RXD
4	4	RTS
5	-	n.c.
6	5	DSR
7	7	GND
8	8	DCD
9	-	n.c.
10	-	n.c.
11	-	n.c.
12	-	n.c.
13	-	n.c.
14	-	n.c.
15	-	n.c.
16	-	n.c.
17	-	n.c.
18	-	n.c.
19	-	n.c.
20	6	DTR
21	-	n.c.
22	-	n.c.
23	-	n.c.
24	-	n.c.
25	-	n.c.

Appendix B – Remote Command Set

Command Overview

The maser responds to five different command functions:

cmc - internal or external synthesizer control configuration

cmf - external frequency setting

cmh - command help

s - short form scan

t – comma delimited text

The following pages detail the command syntax for each command. Parameters within brackets ("[" and "]") are optional and the brackets should not be typed as part of the actual command sequence.

Note: The **cmc** and **cmf** commands require confirmation by a second carriage return <CR> or linefeed (<LF>) in order to affect maser operation. Since most terminals and terminal emulation programs allow a choice of sending the <CR><LF> sequence in place of the <CR> character, enabling of this feature may defeat the normal operation of the commands. For this purpose, please set the carriage return setting on the remote to <CR> only and the terminal echo to the local setting.

The **s** and **t** commands require no carriage return or linefeed to be accepted.

cmc

Allows programming of the configuration digit that determines synthesizer control.

Syntax **cmc** [0/9] <CR><CR>

This command must be followed by a carriage return followed by a second carriage return (or linefeed character) to be accepted.

Parameter 0

Sets the maser synthesizer on internal control. While on internal control the maser synthesizer will use the frequency setting given by the front panel thumbwheel switches.

9

Requests that the maser synthesizer revert to external control. While on external control the maser synthesizer will use the frequency setting given by the external digits (see cmf command).

Example **cmc** 0 <CR><CR>

cmc 9 <CR><CR>

All commands above are valid. The first command sequence will set the configuration digit to 0 resuming internal control. The second command will set the configuration digit to 9.

Notes When requesting external control of the maser synthesizer, the manual override switch on the front panel must be set to SYNTHESIZER EXTERNAL or the maser will remain on internal control.

The SYNTHESIZER EXTERNAL indicator lamp will be off when the switch is in the INTERNAL position, green when the switch is in the EXTERNAL position and the configuration digit is 0, and yellow when the switch is EXTERNAL and the configuration digit is 9.

cmf

Allows programming of the external synthesizer frequency setting.

Syntax **cmf** [*digits*] <CR><CR>

This command must be followed by a carriage return followed by a second carriage return (or linefeed character) to be accepted.

Parameter *digits*

Specifies the new synthesizer digits to the right of the decimal point. Up to seven digits may be entered, replacing the previous setting(s). Digits are entered most significant digit first.

Example **cmf** 6747 <CR><CR>

The command above is valid. This command sequence will set the first four external digits to 6747, leave the remaining three unchanged.

cmf 6747400 <CR><CR>

The command above is valid. This command will set the external digits to 6747400.

Notes New synthesizer digits are stored most significant digit first. In order to change a lesser digit, the preceding digits must be re-entered as well.

cmh

Presents a series of help screens with command usage instructions for all Monitor and Control interactive commands.

Syntax **cmh** <CR>

This command accepts no options.

Example **cmh** <CR>

Available Commands:

S - Short Data Scan.

CMC - Configure Synthesizer I/X.

CMF - Change Synthesizer Frequency.

CMH - Help. Shows This Screen.

Commands require validation with either a <CR> or <LF>. See manual, Appendix A for more detailed description of remote operation.

<SPACE> continues, <CR> Ends.

s

Generates a concise, formatted listing of the instrumental data channels including channel names, synthesizer settings and configuration status.

Syntax s

This command accepts no options. This command does not require a carriage return or a line feed.

Example s

```
00:+00.000, 01:+00.000, 02:+00.000, 03:+00.000, 04:+00.000<LF><CR>
05:+00.000, 06:+00.000, 07:+00.000, 08:+00.000, 09:+00.000<LF><CR>
10:+00.000, 11:+00.000, 12:+00.000, 13:+00.000, 14:+00.000<LF><CR>
15:+00.000, 16:+000.00, 17:+000.00, 18:+000.00, 19:+000.00<LF><CR>
20:+000.00, 21:+000.00, 22:+000.00, 23:+000.00, 24:+000.00<LF><CR>
25:+000.00, 26:+000.00, 27:+000.00, 28:+000.00, 29:+000.00<LF><CR>
30:+000.00, 31:+000.00, <LF><CR>
5,751.678,900,0 5,751.767,456,7 [ 9 / 0 ] <LF><CR><EOT>
```

The first seven lines are the 32 channels identified on the data display list. The last line gives the synthesizer digits set on the thumbwheel switches followed by the external synthesizer digits, a digit indicating the front panel internal/external switch setting and the external configuration digit (see the **cmc** command). The final transmitted character is the end of transmission (EOT) character (ASCII character number four).

t

Generates a comma delimited form of the same information provided in the **s** command, including synthesizer settings and configuration status. All fields are contained on a single line, terminated by <CR><LF>, for convenient import into spreadsheet programs.

Syntax **t**

This command accepts no options. This command does not require a carriage return or a line feed.

Example **t**

```
+11.998,+11.959,-05.320,-05.299,-05.321,+01.325,+20.070,+20.070,+20.070,+20.070,
+01.333,-05.277,+20.070,+11.993,-01.394,+11.990,+024.08,+024.13,+024.08,+024.08,
+023.98,+004.71,+024.13,+024.03,+024.03,+023.93,+001.04,+001.04,+001.04,+001.04,
+001.02,+001.01,5761.7093111,5761.000000,9,0 <CR><LF>
```

The first 32 columns contain the 32 channels identified on the data display list, followed by the synthesizer digits set on the thumbwheel switches and the external synthesizer digits. A digit indicating the front panel internal/external switch setting and the external configuration digit completes the data stream.

Appendix C – Figures and Diagrams

Figure 1 Hydrogen Maser Elevation.....	24
Figure 2 Maser Block Diagram	25
Figure 3 Hydrogen Maser, System Layout and Identification.....	25
Figure 4 Hydrogen Maser, Physics Layout and Identification	27
Figure 5 Stability Plot, Typical.....	28

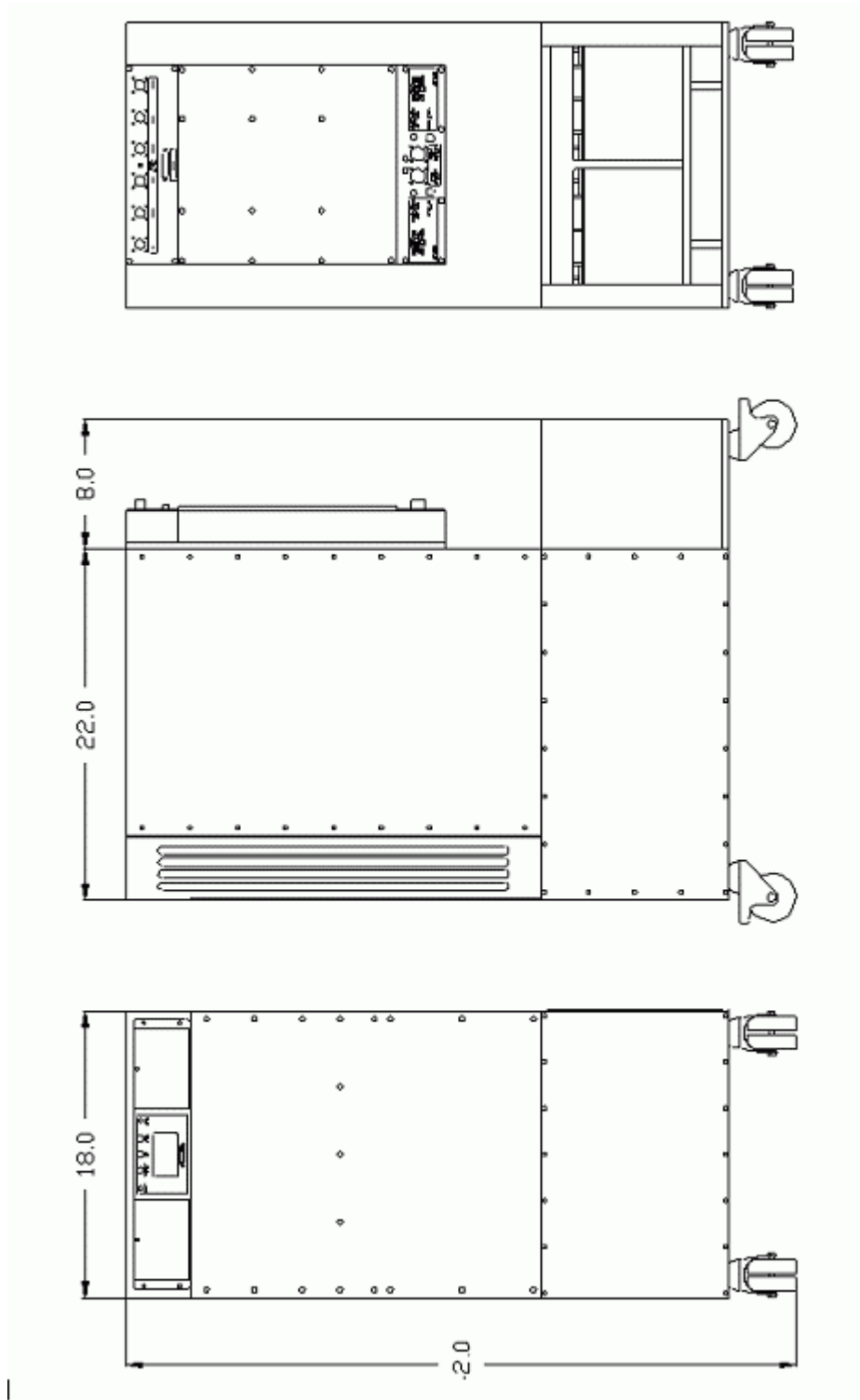

Figure 1. Hydrogen Maser Elevation

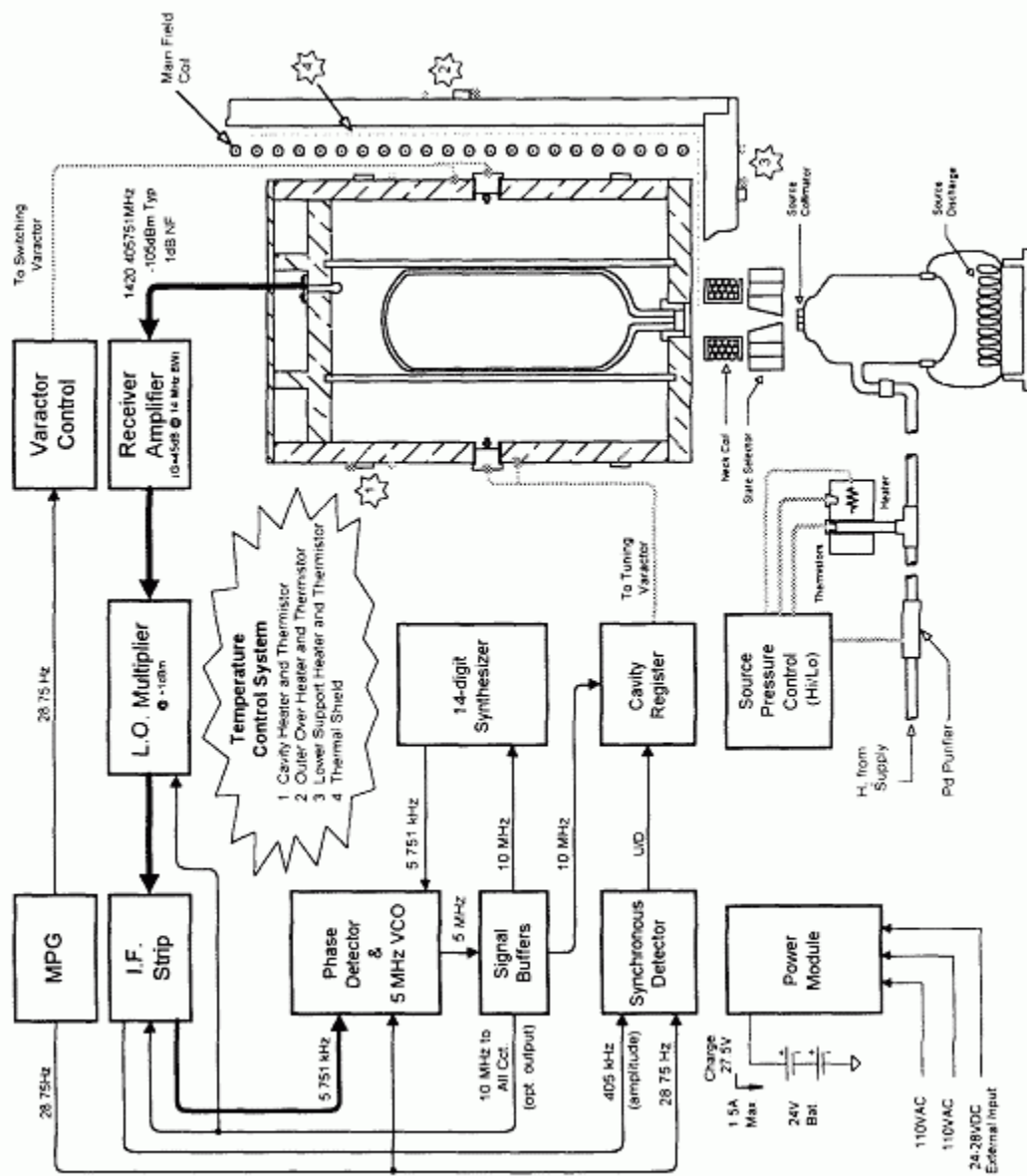

Figure 2. Master Block Diagram.

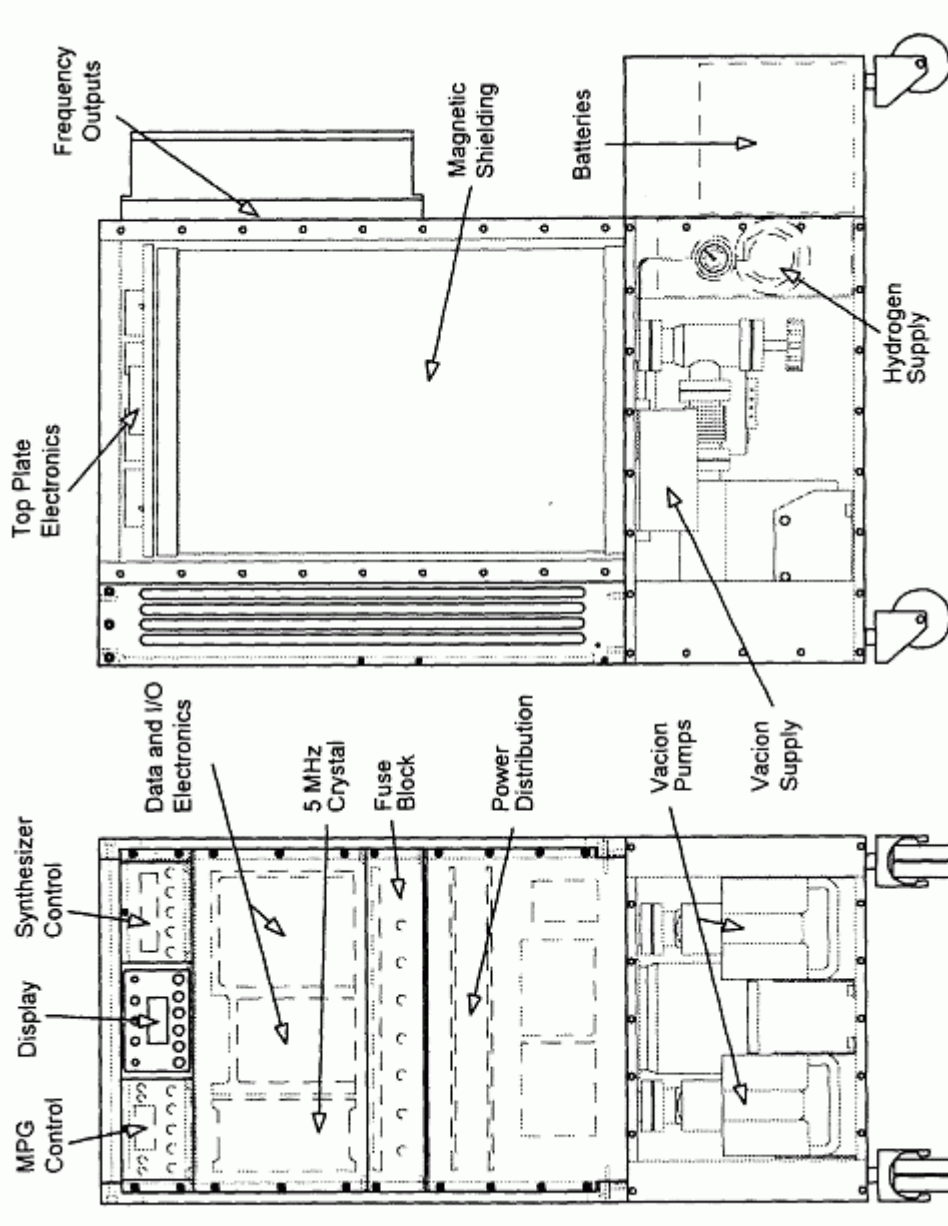

Figure 3. Hydrogen Maser, System Lay-out and Identification.

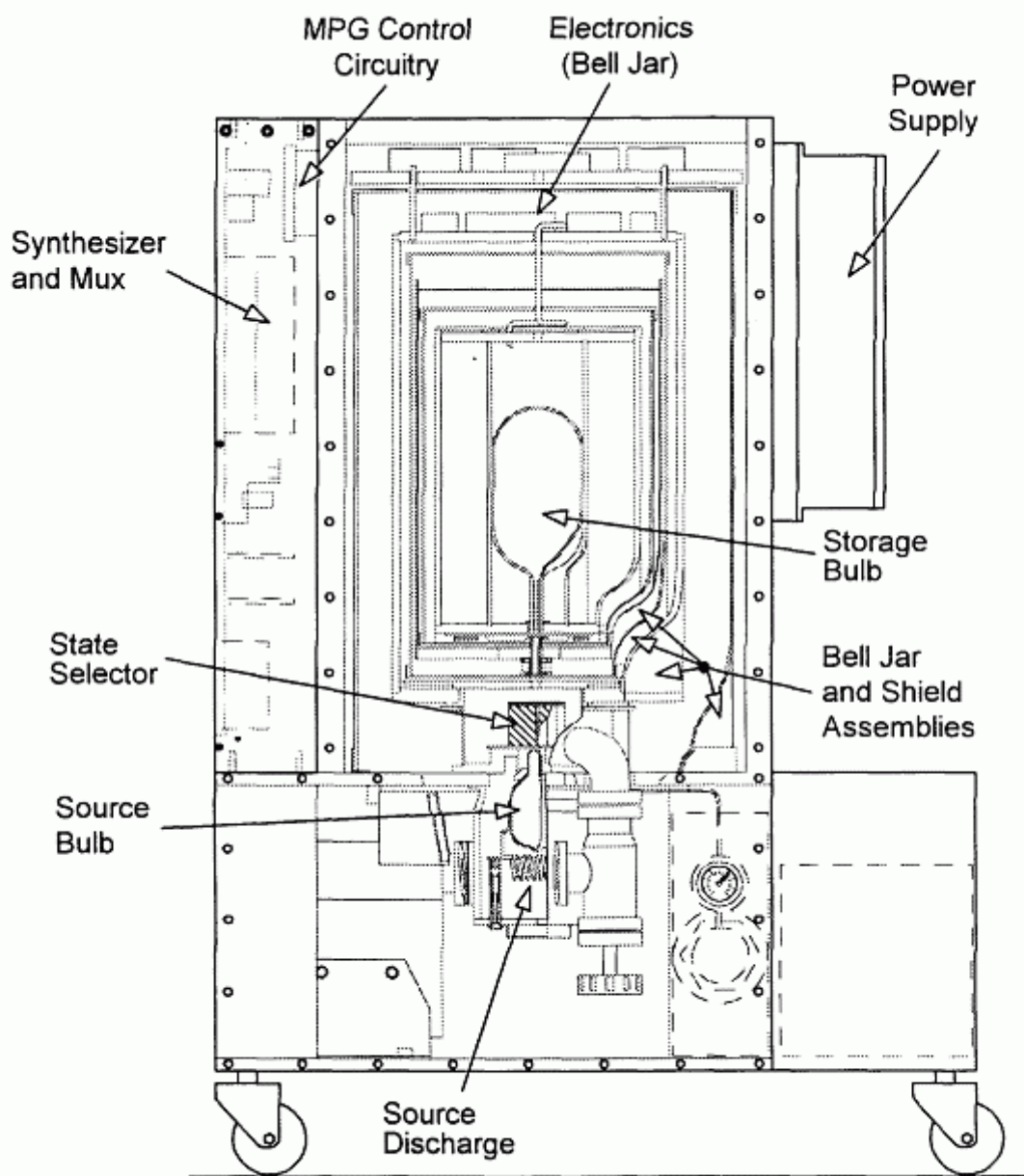

Figure 4. Hydrogen Maser, Physics Layout and Identification.

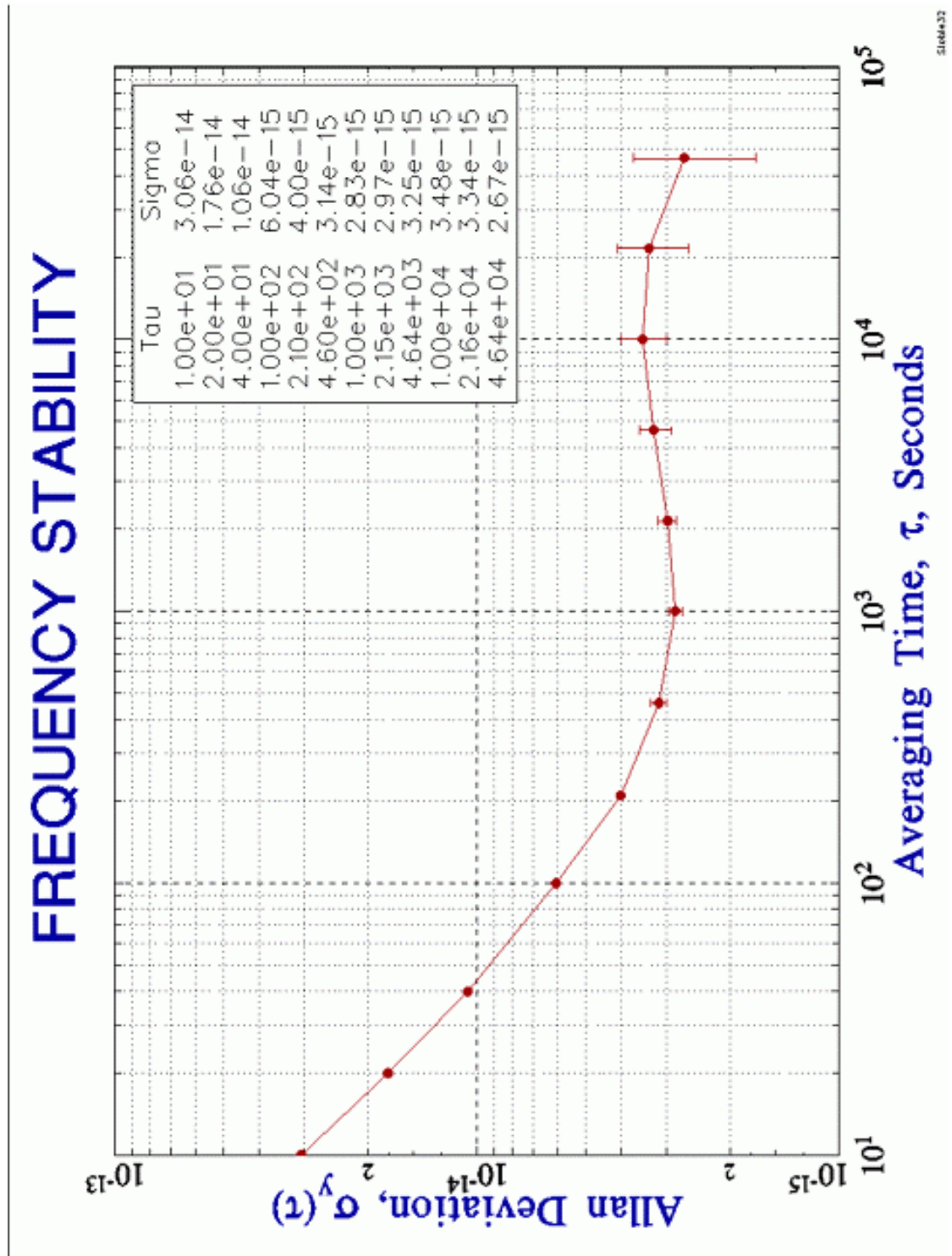

Figure 5 Stability Plot, Typical

Appendix D – Start-up Procedure

Please check for shipping damage, condition of all shipping indicators and read all steps before continuing.

1. Take the side marked RAMP off of the maser crate by unscrewing the red colored bolts (see Figures 1 and 4).
2. Remove the red colored bolts at the bottom of the 3 remaining sides.
3. Slide the 3 sides and top off the crate base (see Figure 1).
4. Remove the two tie down straps (see Figure 4).
5. Unscrew the caster blocks (see Figure 4).
6. Remove the marked 2x4 piece off the end of the RAMP (see Figure 2).
7. Set the RAMP up against the end of the crate base and secure it to the base 4x4 with one of the tie down straps from the maser (see Figure 3).
8. Gently and carefully roll the maser down the ramp. **THE MASER WEIGHS APPROX. 500 lbs; SEVERAL PEOPLE SHOULD BE USED TO STEADY THE MASER.**
9. Plug in either or both maser AC power cords. Power system will automatically select between 110 or 220 VAC.
10. The front panel display for the vacion pumps (channels 3 & 4) should read less than -0.010.

STEPS 11 THROUGH 14 WILL TAKE APPROXIMATELY 1 TO 2 HOURS TO COMPLETE.

11. On the maser lower side that is open, very slowly (**DO NOT EXCEED 1 REVOLUTION PER MINUTE**) open the gold vacuum valve (see Figures 4 and 5) that is closest to you while monitoring channel 3 (H₂ pump) on the front display. Open until you get a reading of -1.2 (do not exceed -1.5 V; if you do, close the valve until the channel reads less than -1.2).
12. Remove the lower side panels in order to gain access to the other gold vacuum valve. (Both lower side panels are attached on one side for shipping).
13. Repeat the above procedure with the other gold vacuum valve while monitoring channel 4 (upper).
14. Continue to slowly open the valves, working back and forth between the 2 gold vacuum valves, keeping the readings below -1.2 (see Figure 5).
15. When the pump readings no longer exceed -1.2 continue to open the valve all the way then close back ¼ of a turn. Valves will be left open hereafter.
16. When gold vacuum valves are both fully open, remove the maser's front cover (19 flat head Philips screws) to access the switches shown (see Figure 7). Turn on all power switches (Bat handles on toggle switches to left) **EXCEPT DISCHARGE CIRCUIT, LABELED ON THE CIRCUIT BOARD AS (DISCH).**

17. The Hydrogen generator is located on the right hand side of the originally open lower section (see Figure 6). Open the small green H₂ generator valve by $\frac{3}{4}$ of a turn. (HANDLE CAN SCREW OFF AND MAY BE SCREWED BACK ON WITHOUT ANY LOSS OF HYDROGEN).
18. Monitor channel 17 (palladium heater). When its voltage falls below 14 V (this will take approximately 1 hour), turn on the Discharge circuit.
19. Replace lower shield panels.
20. Within three days the maser should be operating (the IF level (channel 0) will be above 3 V).
21. When the IF level is above 3 volts, the register should be reset. Using the controls behind the left control panel door, follow the procedure below:
 1. RUN/HOLD switch should be moved to HOLD
 2. The UP/DOWN switch should be moved to DOWN
 3. The RESET button should be pressed
 4. This should bring the REGISTER VOLTAGE (CHANNEL ONE) to approximately 4.8 to 5 volts
 5. Move the UP/DOWN switch to the center position
 6. Move the RUN/HOLD switch to RUN

After the register has been reset, the maser will automatically return to its tuned position in a few days. The register must be reset before it will automatically tune. Refer to chapter 3 on the Cavity Servo System for a more detailed explanation.



Figure 1: Sides and top off the crate base.

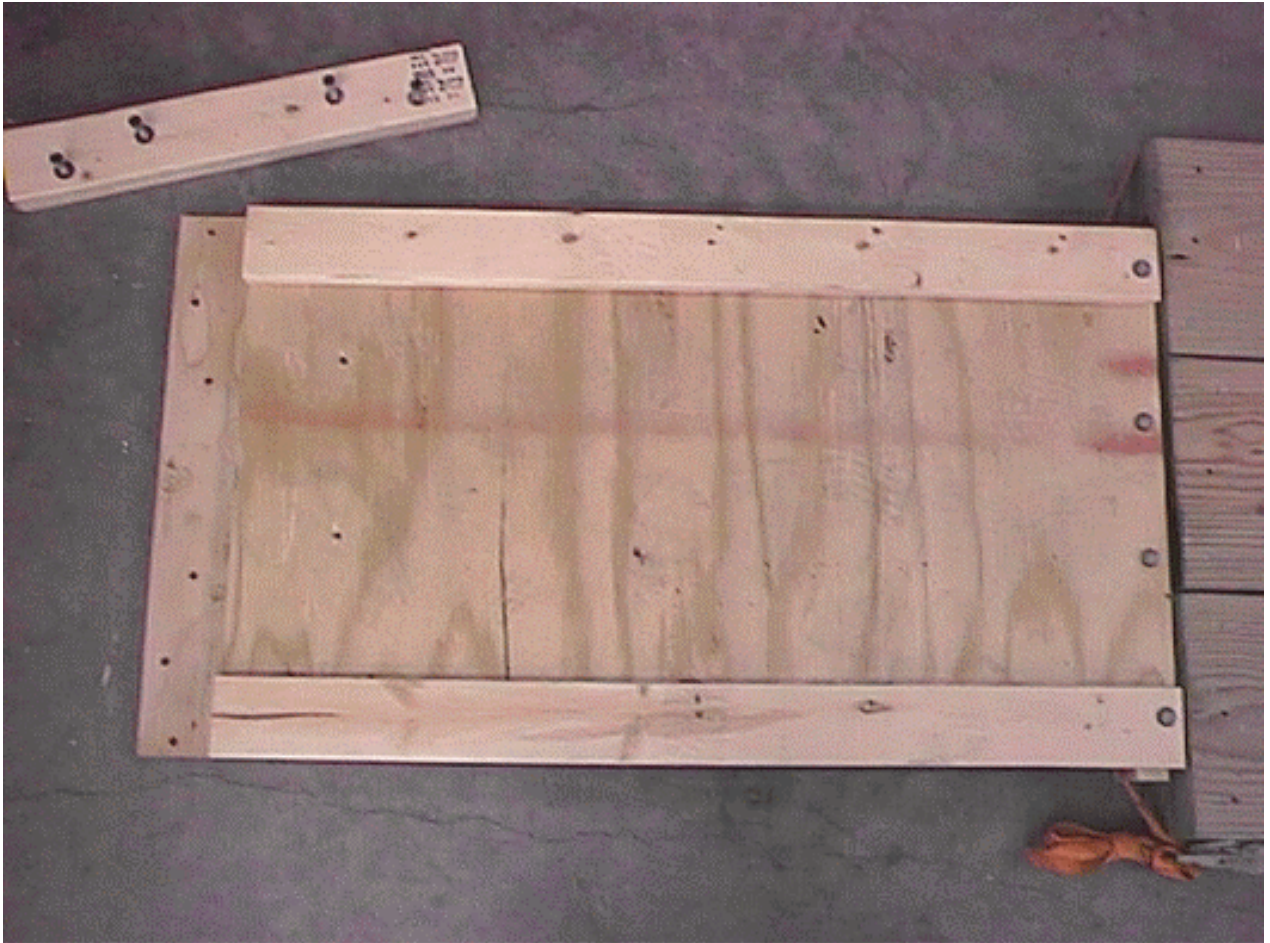

Figure 2: Remove the marked 2x4 piece off the end of the RAMP.



Figure 3: Set the RAMP up against the end of the crate base and secure it to the base 4x4 with one of the tie down straps from the maser.

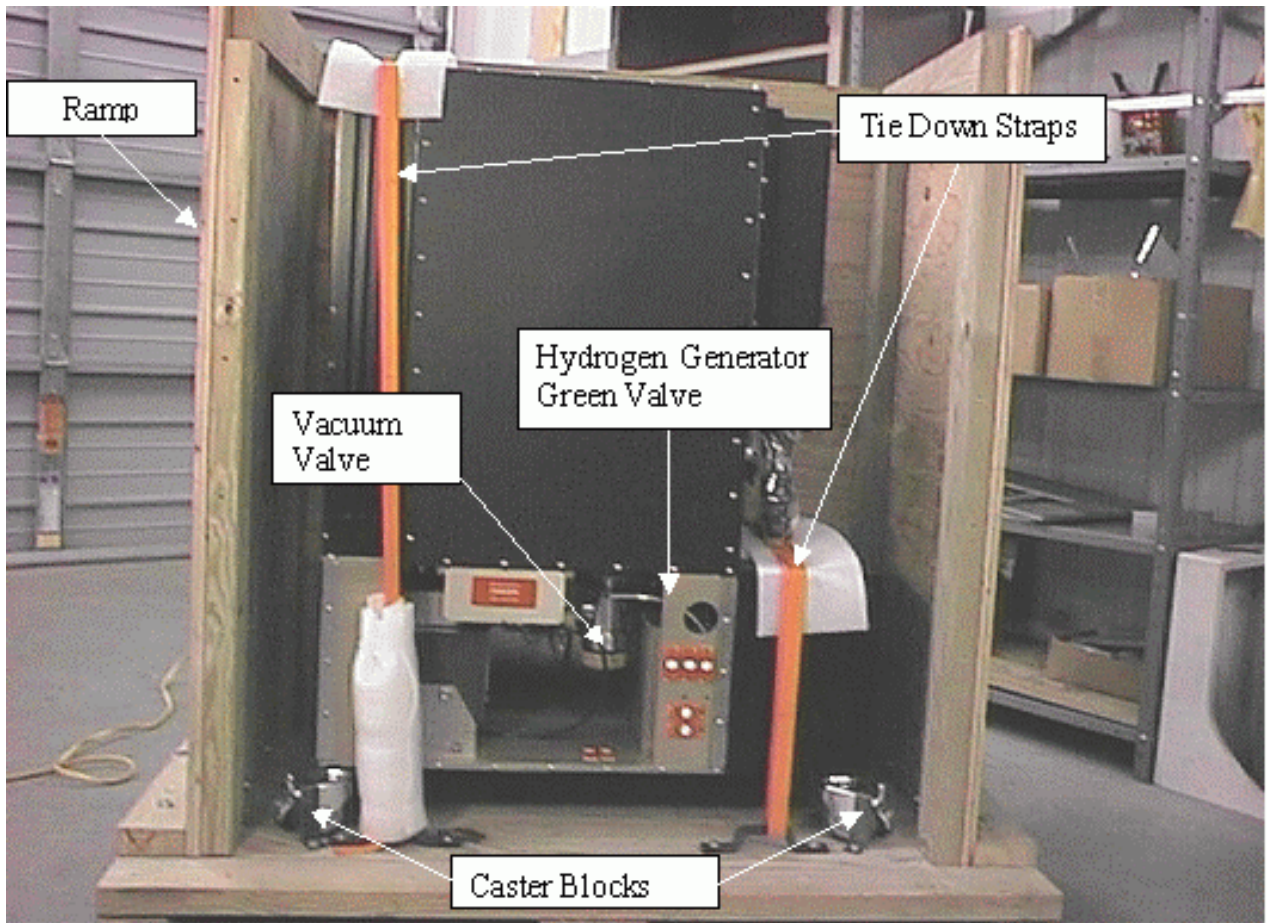

Figure 4

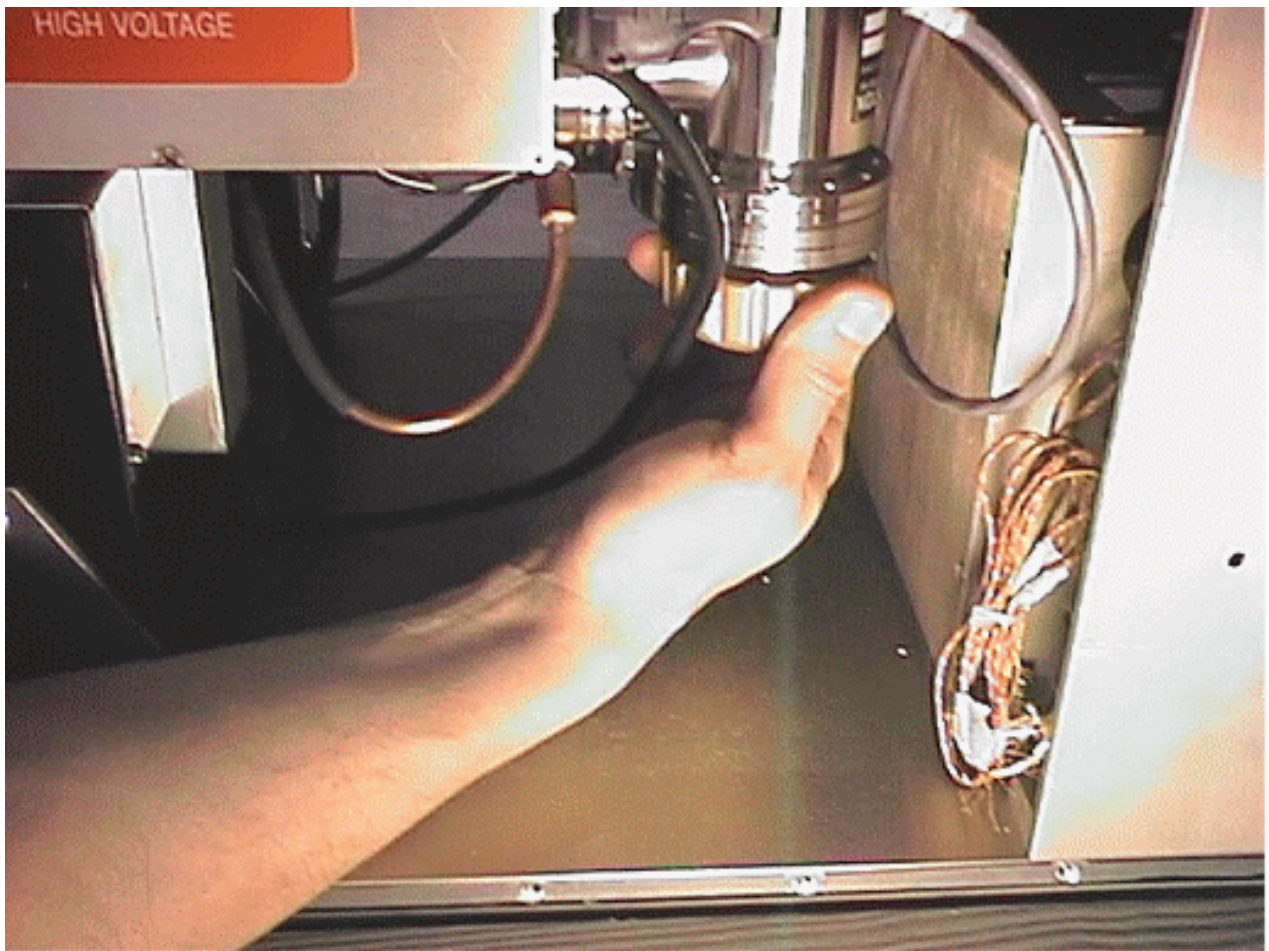

Figure 5: On the maser lower side that is open, very slowly (DO NOT EXCEED 1 REVOLUTION PER MINUTE) open the gold vacuum valve.

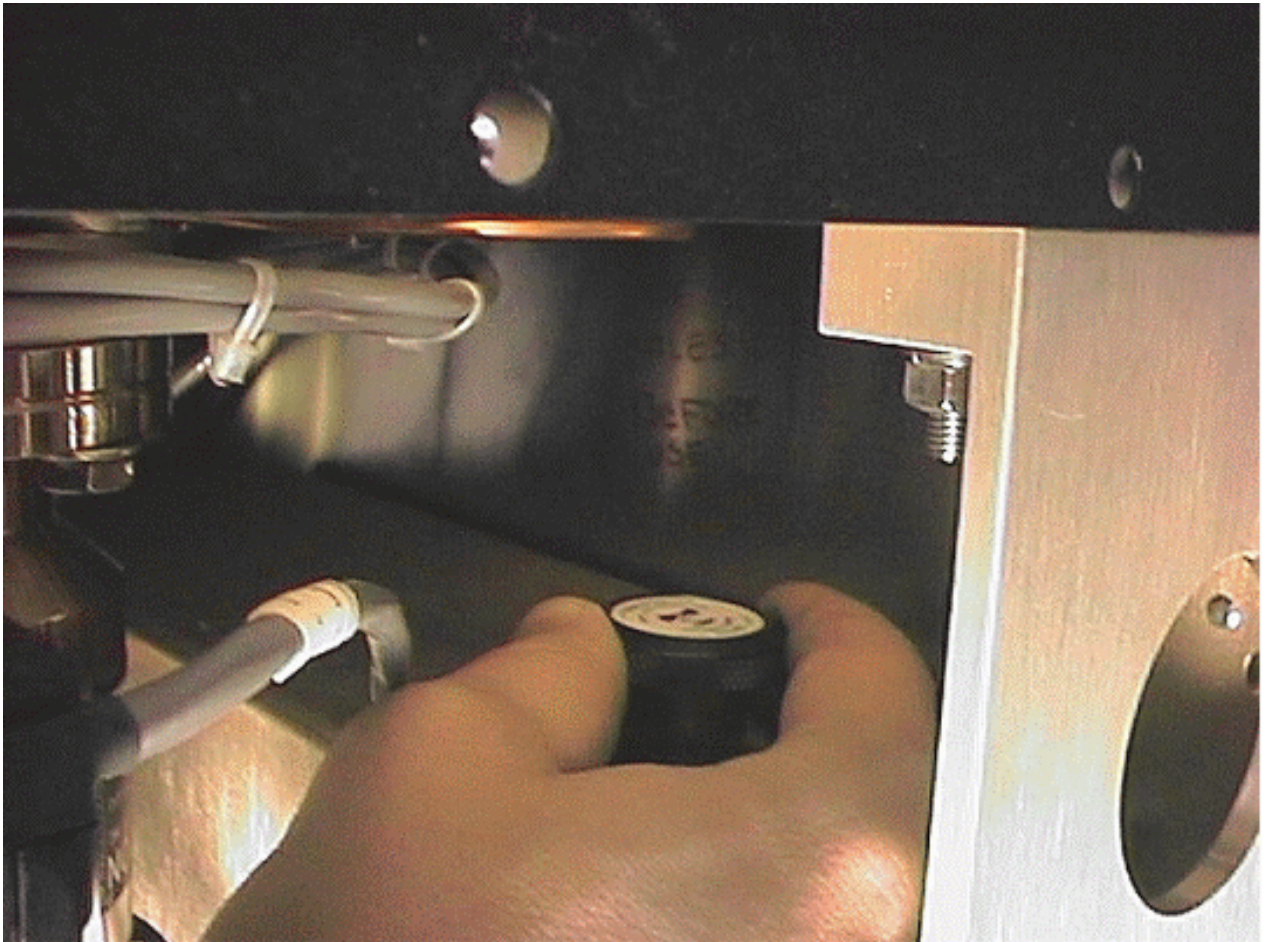

Figure 6: Open the small green H₂ generator valve by $\frac{3}{4}$ of a turn.

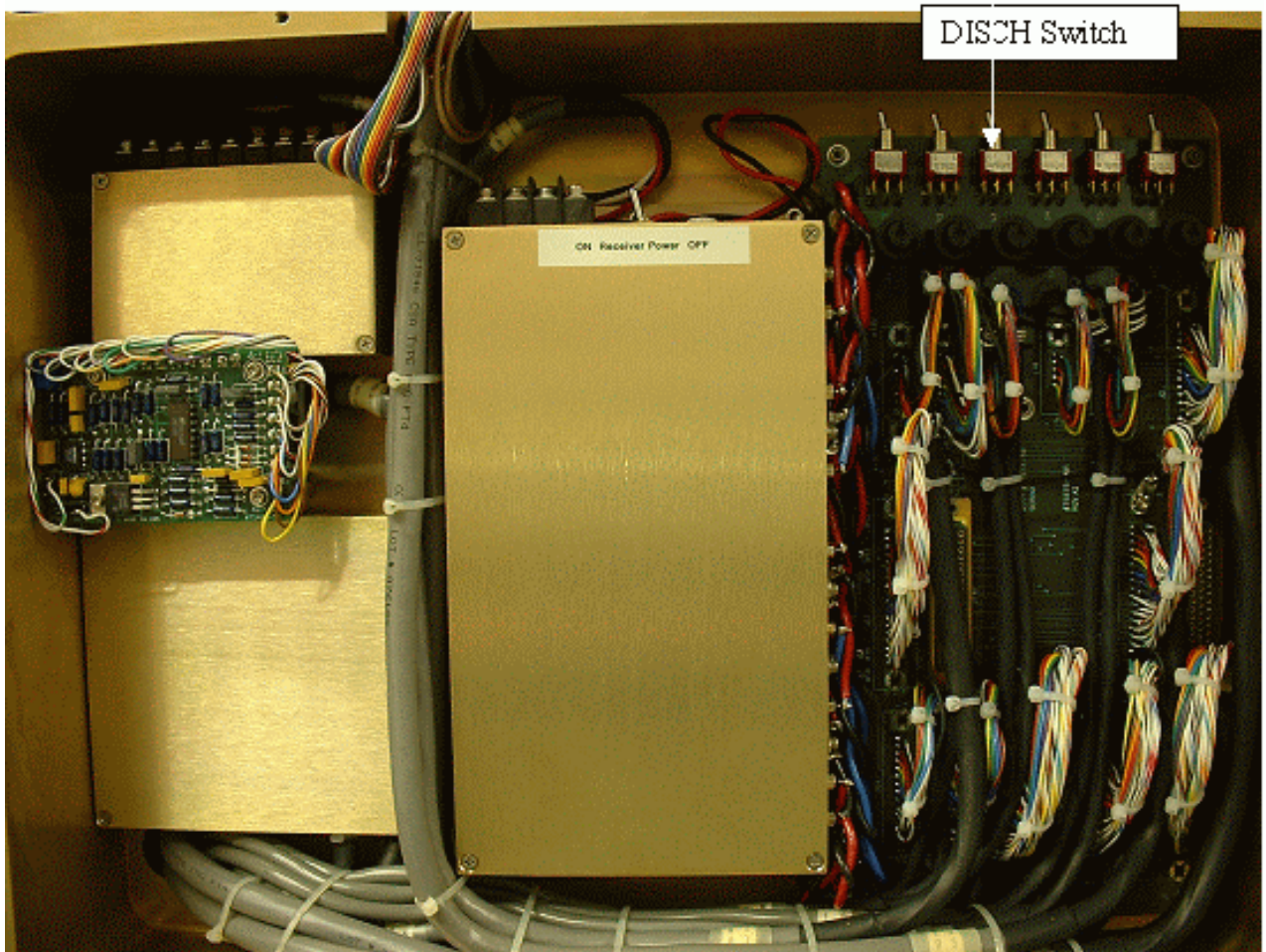

Figure 7: When valves are both fully open, remove the maser’s front cover to access the switches as shown. See Step 18 for details.



Figure 8: Register Controls.

Appendix E – MaserMonitor Information

Requirements

MaserMonitor.exe runs well on Windows-98, Windows-2000, and Windows-XP. MaserMonitor.exe requires 500 KB of disk space for installation and an available RS232 (COM) port to connect to the maser. If you're going to use the plotting features it's nice (but not essential) to have a 17" monitor and 1024x768 resolution.

Supported Instruments

MaserMonitor provides complete support for all MHM-2010 Active Hydrogen Masers, including those produced prior to the implementation of the front panel SBC.

Installation

Run setup.exe from DOS command line or Windows "Run..." menu or just double-click it from the Explorer. Accepting all defaults will install MaserMonitor.exe in c:\Program Files\Symmetricon\MaserMonitor.exe. Installation will also add a new menu item to the Windows "Start" menu as Symmetricon\MaserMonitor and place a link to MaserMonitor.exe on the desktop.

Note that installer also installs the active-X control, DynaPlot3.ocx, in the c:\Program Files\Symmetricon folder and creates registry entries to inform the OS of the control.

The installer creates filetype associations for files of type .hmd (hydrogen maser data files) so that double-clicking files of this type launches MaserMonitor.

Usage

MaserMonitor can be launched by double-clicking the desktop icon, selecting its menu item or executing MaserMonitor.exe from a DOS command line.

MaserMonitor can also be launched in "Viewer mode" by double-clicking a file of type .hmd, by drag and dropping a file of those types onto the MaserMonitor icon, or by executing MaserMonitor.exe from the command line with a filename (of type .hmd) as the first argument.

Set program up to monitor once per hour on COM1 & save data to a file c:\temp\mhm2010.hmd:

File, Options:

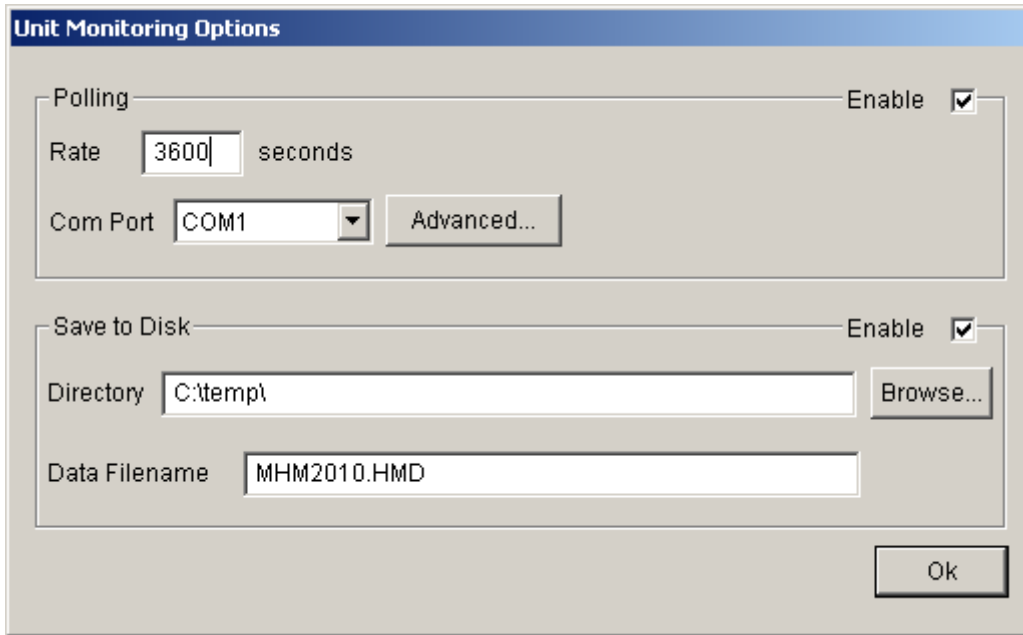

Com Port Advanced . . .

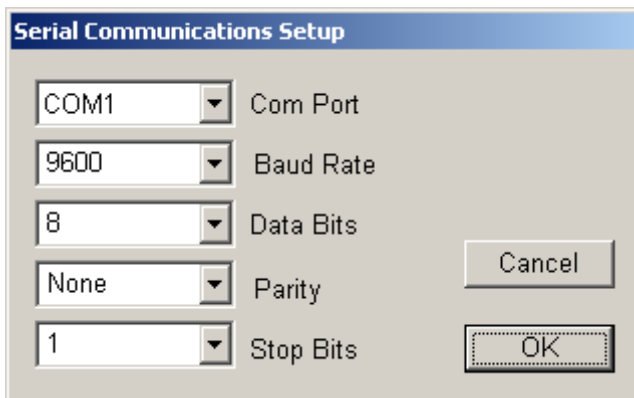

To view a graphical display of the data:

View, Plot opens up a window similar to the one below.

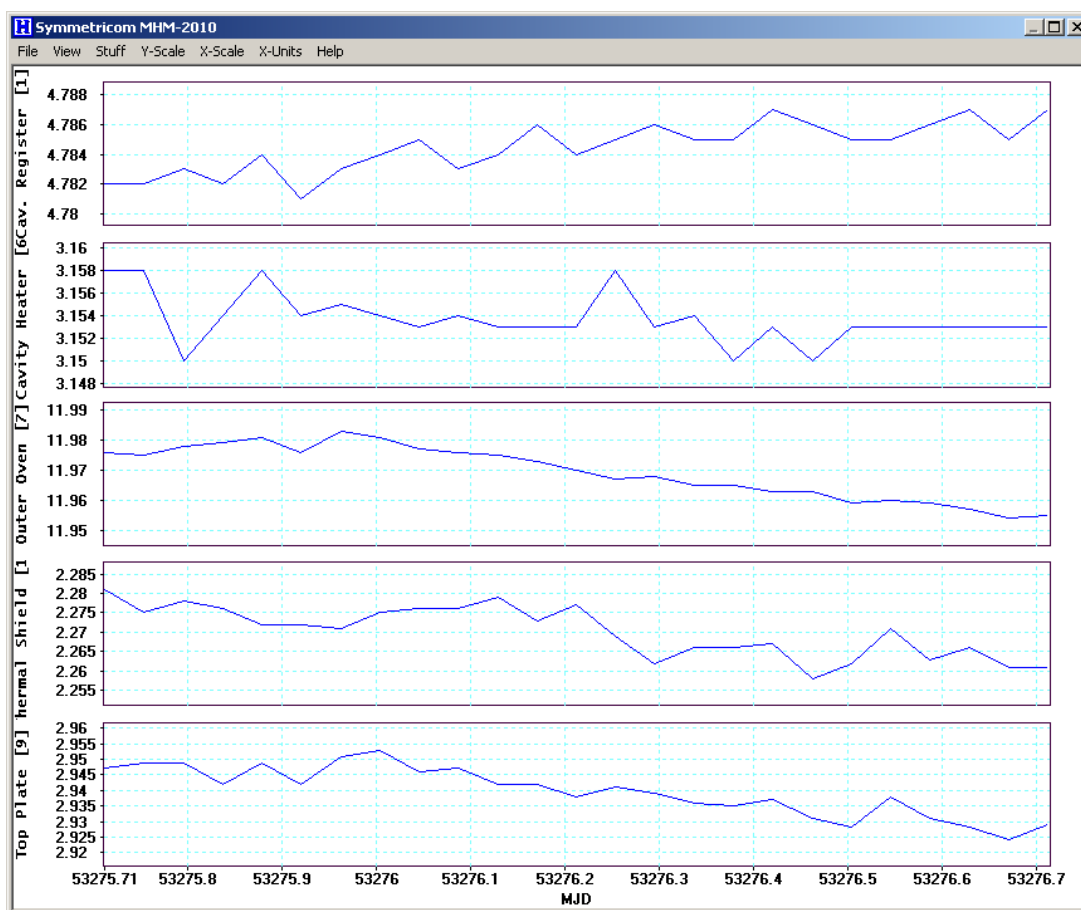

Cursors

left mouse button

Drag left Cursor

right mouse button

Drag right Cursor

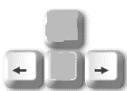

Move active cursor

Shift +

Fast move active cursor

Pan & Scroll

Ctrl+

Pan and scroll

Zoom

r	Rescale to menu settings
Ctrl+left mouse button	Draw zoombox
Ctrl+left mouse button up	Zoom

Miscellaneous

Ctrl-C	Copy bitmap to the clipboard
--------	------------------------------

To view synthesizer settings:

System, Synthesizer opens up a window similar to the one below.

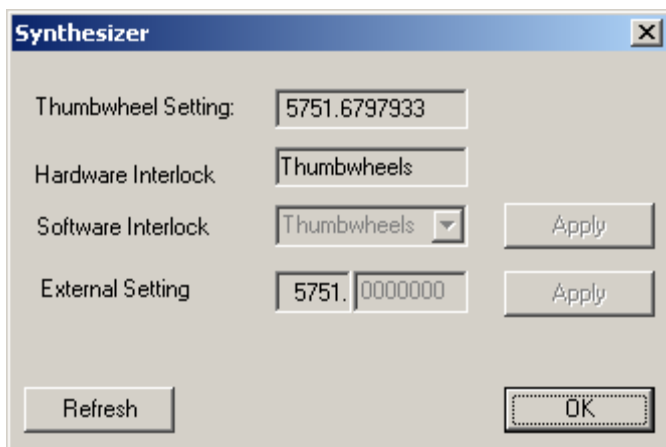

Appendix F – References

1. H. E. Peters and P. J. Washburn, "Atomic Hydrogen Maser Active Oscillator Cavity and Bulb Design Optimization," Proceedings, 16th annual PTTI Meeting, 1984.
2. H. E. Peters, "Design and Performance of New Hydrogen Masers Using Cavity frequency Switching Servos," Proceedings, 38th Frequency Control Symposium, 1984.
3. H. E. Peters, H. B. Owings and P. A. Koppang, "Hydrogen masers With Cavity Frequency Switching Servos," Proceedings, 22nd annual PTTI Meeting, 1990.
4. H. E. Peters, "Magnetic State Selection in Atomic Frequency and Time Standards," Proceedings, 13th Annual PTTI Meeting, 1981.
5. H. E. Peters, "Characteristics of Advanced Hydrogen Maser Frequency Standards," Proceedings, 5th Annual PTTI Meeting, 1973.
6. S. B. Crampton, "Spin-Exchange Shifts in the Hydrogen Maser," Phys Rev 158, 1, pp. 57-61 June 1967.
7. V. Reinhart and H. E. Peters, "An Improved Method for Measuring the Magnetic Inhomogeneity Shift in Hydrogen Masers," Proceedings, 29th Frequency Control Symposium, 1975.
8. D. Kleppner, et al, "Hydrogen Maser Principles and Techniques," Phys Rev 138, 4A, A971-A983, May 1965.
9. N. F. Ramsey, "History of Atomic and Molecular Standards of Frequency and Time," IEEE Trans. on Inst. & Meas. IM-21, Pp 90-99, May 1972.
10. H. E. Peters, B. Owings and T. Oakley, "Hydrogen Masers For Radio Astronomy," Proceedings, 41st Frequency Control Symposium, May, 1987.
11. H. E. Peters, H. B. Owings and P. A. Koppang, "Atomic Hydrogen Masers With Self Auto-Tune System And Magnetic Field Cancellation Servo," 20th Annual PTTI Meeting, November, 1988.
12. E. Powers and A. Gifford, "Hydrogen Maser Performance at the United States Naval Observatory and the Naval Research Laboratory," 1991 Frequency Control Symposium, May 1991.
13. H. B. Owings, P. A. Koppang, C. C. MacMillan and H. E. Peters, "Experimental Frequency and Phase Stability of the Hydrogen Maser Standard Output as Affected by Cavity Auto-Tuning," 1992 Frequency control Symposium, May, 1992.
14. Parker, T. E., Gray, J. E., and Pepler, T. K, "Environmental Sensitivities of Cavity-Tuned Hydrogen Masers," 1997 Frequency Control Symposium, May 1997.

Index

- A**
- Air Shipment, 14
- B**
- Battery Charge Current, 5
- C**
- Cavity Averager, 6
Cavity Heater, 5
Cavity Register, 4
Cavity Servo System, 11
- D**
- Data Display List, 8
Data Monitoring, 4
DCx, 6
Degaussing, 11
- I**
- IF
 alarm, 6
 amplitude, 4
Installation, 14
- M**
- Magnetic Field Control, 11
Main Bus Voltage, 6
MaserMonitor, 39
MPG
 adjusting, 10
 resetting, 10
- O**
- Oscillation Level, adjusting, 10
- P**
- Power Supply, 12
Pressure Calibration, 10
- R**
- Receiver, 9
Remote Monitoring, 15
RS-232 Pin-out, 16
- S**
- Serial Communication, 15
Short Scan, 21
Shut Down
 full, 14
 partial, 13
Source Discharge, 5, 6, 11
 restarting, 11
Source Pressure, 5
Source Pressure Control, 9
Synthesizer, 9
Synthesizer
 calibration factor, 9
- T**
- t command, 22
Transporting, 13
- V**
- VCO, 9
 adjusting frequency, 9
 alarm, 6
 coarse frequency control, 9
 confirmation of lock, 9
 control voltage, 4, 9
 heater, 5
 lock range, 9